

ENCLOSED SAFETY SWITCHES

Enclosed safety (grabwire) switches are the equipment of choice to provide safety protection over long distances. Prior to the development of Grabwire switches, machinery such as conveyors had to be fitted with a number of separate Emergency Stops. Positioning the 'Stops' such that at least one could be reached from any point, was often difficult to fulfil.

Conveyors are the obvious application for such devices, but with the ability to take the protection wire around bends, and provide safety cover over both horizontal and vertical runs, the system lends itself to many different applications.

Reference standards:-

BS EN ISO 12100-1:2003 Pts. 1 & 2 | BS EN 418 | BS EN 60947-5-1 | BS EN 60529 | BS EN 60947-5-5 | BS EN 60204-1 | PD 5304.



GW Range

The 'GW' range, is a tensioned wire system which is designed to cover small to medium sized runs. (Up to 100m max. between pairs). A Grabwire switch assembly gives a continuous and uninterrupted safety provision over long distances.

Prior to the development of Grabwire switches, machinery such as conveyors had to be fitted with a number of separate Emergency Stops. Positioning the 'Stops' such that at least one could be reached from any point, was often difficult to fulfil. Conveyors are the obvious application for such devices, but with the ability to take the protection wire around bends, and provide safety cover over both horizontal and vertical runs, the system lends itself to many different applications.





The minimum requirements in this situation would be a Grabwire Switch at one end and an Anchor Box at the other.

The effective installation involves the fitting of Grabwire switches at both ends of the 'pull wire'. However, this does involve electrical cabling up to, and between, the switching units. The use of a non electrical 'Anchor Box' at one end removes the need to cable between the end assemblies.

The 'Anchor Box' effectively houses a long spring, which is compressed when the 'pull wire' is activated. At a fixed point during the compression, a latch is operated which locks the spring in the compressed or shortened state. When the 'pull wire' is released, it will be in a 'slack' condition, and the switching unit at the other end of the 'pull wire' senses the 'slack' condition and activates the 'Stop' signal. Although the 'Anchor Box' contains no electrical contacts, the latch needs manual resetting to restore the system.

Apart from the Grabwire switch, the only other item required in a simple set-up, is the connection kit. In the kit you will find all the parts necessary to install the system.



Image				
Cat. No.	GWN1	GWN2	GWN2/SS	GWDE
Description	Universal single ended	Universal single ended	Universal single ended	Universal double ended
Max. span between pairs (L) (or between switch & anchor box)	50m	100m	100m	2 x 100m
Encl. material	Die-cast Aluminium (LM24)	Die-cast Aluminium (LM24)	Stainless Steel 1.6 mm Grade 316	Sheet Steel 1.6 mm
Finish	Textured Powder Coat RAL 3020	Textured Powder Coat RAL 3020	Polished	Textured Powder Coat RAL 3020
Ingress Protection	IP65	IP65	IP65	IP65
Rope Tensioner	Included	Included	Included	Included
Earthing	M4 Internal & External	M5 Internal & External	M5 Internal & External	M5 Internal & External
Electrical Contacts	2 N/C (Safety) + 1 N/O	2 N/C (Safety) + 2 N/O	2 N/C (Safety) + 2 N/O	2 x {2 N/C (Safety) + 2 N/O}
Electrical Rating:- Ith / Ui	10A/415V	10A/415V	16A/600V	16A/600V
AC21/22/23A to BS EN 60947-3	-	-	16A at 415V	16A at 415V
AC15 to BS EN 60947-5-1	5A at 415V	5A at 415V	5A at 415V	5A at 415V
Optional Indicator Lamp	✓	✓	-	-
Setting-up indicator	✓	✓	✓	✓
Hand reset knob	✓	✓	✓	✓
Universal (LH or RH) mounting	✓	✓	✓	✓
Image	Description			Cat. No.
	Each connection kit includes:- <ul style="list-style-type: none"> Multi strand steel catenary cable with red PVC covering* Stainless steel eyebolt supports. Sufficient to support the cable at 2M intervals. Supplied complete with two fixing nuts* 2 x Stainless steel thimbles 2 x Stainless steel 'D' shackles 2 x Stainless steel clamps 			Basic - GK00* Up to 5m - GK5 Up to 10m - GK10 Up to 20m - GK20 Up to 50m - GK50 Up to 75m - GK75 Up to 100m - GK100

Minimum Installation Requirements

When planning a grabwire installation, it is vital that the operators safety is always the primary objective. Plan the route of the 'pull wire' carefully to ensure maximum accessibility by the possible users. Ensure that supports can be placed at a maximum of 2m spacing. The placement of the grabwire switches need to be in reachable positions for setting-up, monitoring and resetting after an incident.

It is necessary to place the first eyebolt close to the switching body to ensure that if the wire is pulled at a very oblique angle, then the pull on the switch remains linear. Although corners/bends can be incorporated in the run, try to avoid too many. It may be necessary to install additional systems to ensure an effective installation. The ultimate objective must be to provide a free running 'pull wire' with the minimum of resistance to movement.

Measure each run and select a Grabwire switch whose max. span (L) is greater than the measured distance. If the total length is over 100m, then multiple installations will be necessary. If the length is excessive, then consider using the 'LW' system. Choose the Stainless Steel grabwire switch option if the working environment will be continuously wet or subject to systematic cleansing routines.

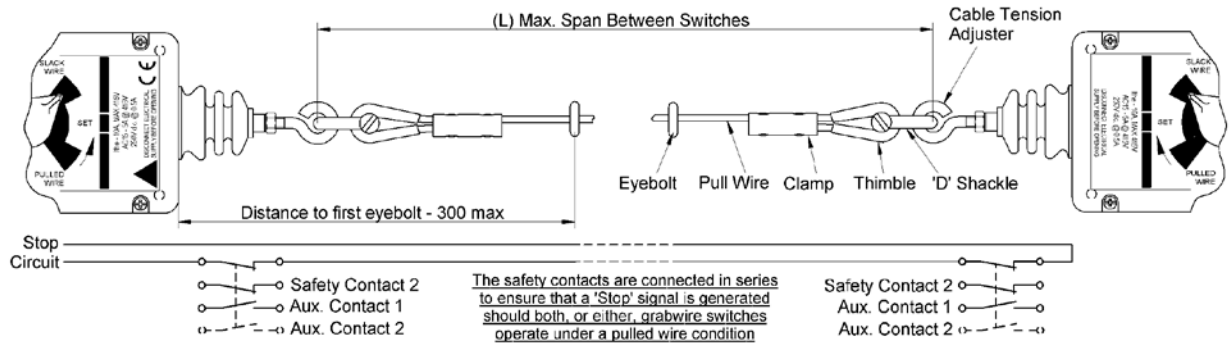

Accessories

To assist with the possible variations necessary when designing an installation, the following accessories are available.

Image	Description	Cat. No.
	Non Switching Anchor Box with manual reset	GW/AB
	Indicator lamp, which when powered through one of the spare N/O contacts, will indicate which grabwire switch has been actuated. (Indicates on 'Pulled' or 'Slack Wire' conditions) Supplied complete with bulb. Other colours and supply voltages available to order. 24V (Amber) Annunicator Lamp 110V (Amber) Annunicator Lamp	GW024A GW110A
	Stranded steel 'pull wire' with red PVC covering. (Ø5 approx O/D) Sold per Metre. Pull Wire (As supplied in the connecting kits)	MR 0221
	Standard length 'eyebolt' for 'pull wire' support. Supplied complete with 2 x locking nuts. Material- Stainless steel, Size - M6, Overall length - 80, Thread length - 58 Standard M6 Eyebolt (As supplied in the connection kits)	GWA 0070
	Extended length 'eyebolt' for 'pull wire' support. Supplied complete with 2 x locking nuts. Material - Stainless steel, Size - M6, Overall length - 230, Thread length - 200 Extended M6 Eyebolt	GWC 0270
	Wrap around 'thimble' to terminate the 'pull wire'. Material - Stainless steel Termination 'thimble' (As supplied in the connection kits)	GWC 0163
	'D Shackle' to connect the 'pull wire' to the grabwire switches. Material- Stainless steel Connection 'D Shackle' (As supplied in the connection kits)	GWC 0166
	Cable clamp for securing the 'pull wire' back upon itself once passed around the 'thimble'. Tightening via 2 x Allen screws. Material - Stainless steel Cable clamp (As supplied in the connection kits)	GWC 0167
	Allen key for tightening 'Cable Clamp' above. Size- 2.5 A/F Allen Key (As supplied in the connection kits)	GWC 0189







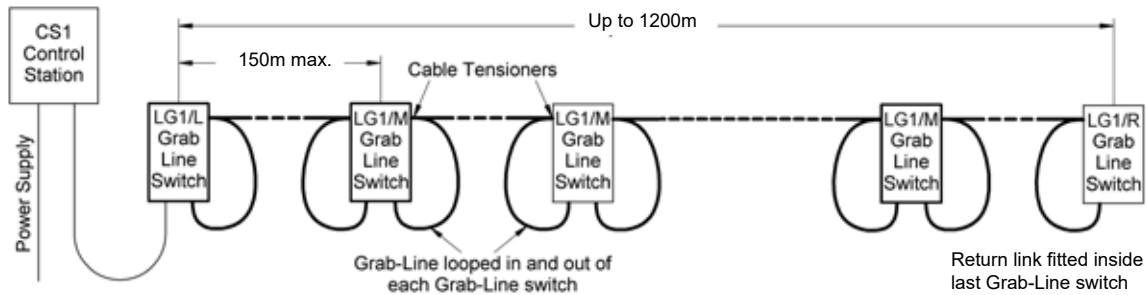

LW Range

Designed specifically for long distance protection, where a tensioned wire installation (GW series) becomes expensive or impractical. The 'LW' range system incorporates the following safety features:-

- The trip switch interior to each grabwire assembly contains positive push-off contacts.
- The system will trip in the event of-
 - (a) a Grab-Line being pulled in any direction.
 - (b) a Grab-Line being broken or the Grab-Line circuit interrupted.
 - (c) a short circuit condition occurring in the Grab-Line circuit.
 - (d) a loss of power to the Control Station.
- Once tripped, the system requires manual resetting.
- Only a safe low voltage is applied to the Grab-Line circuit and Grab-Line switch assemblies.

The system is ideal for heavy duty and exposed situations. The Control Station and Grab-Line switch assemblies are housed in substantial enclosures which are sealed to IP65. Stainless steel components are used where necessary to ensure reliability is maintained.



	Description	Cat. No.
	A control station assembly required for each installation. The sheet steel housed control station contains the following equipment: <ul style="list-style-type: none"> • On/Off switch • 'Supply On' Indicator Lamp (Blue) • 'Reset' Pushbutton • 'Reset System' Indicator Lamp (White) • 'System Tripped' indicator Lamp (Red) 	CS1
	LH Grab-Line switch housed in heavy duty die-cast aluminium enclosures. <ul style="list-style-type: none"> • Manual 'Reset/Condition Indicator' knob • 'Signal to Reset' pushbutton 	LG1/L
	RH Grab-Line switch housed in heavy duty die-cast aluminium enclosures. <ul style="list-style-type: none"> • Manual 'Reset/Condition Indicator' knob • 'Signal to Reset' pushbutton 	LG1/R
	Mid Grab-Line switch housed in heavy duty die-cast aluminium enclosures. <ul style="list-style-type: none"> • Manual 'Reset/Condition Indicator' knob • 'Signal to Reset' pushbutton 	LG1/M
	Grab-Line cable (75m). Thick outer sheath of red PVC. Flexible steel wire armour	GWC 0038A
	Grab-Line cable (100m). Thick outer sheath of red PVC. Flexible steel wire armour	GWC 0038B
	Grab-Line cable (125m). Thick outer sheath of red PVC. Flexible steel wire armour	GWC 0038C
	Grab-Line cable (150m). Thick outer sheath of red PVC. Flexible steel wire armour	GWC 0038D
	Stainless Steel Eyebolt with fixing nuts	GWA 0070
	Grab-Line Thimble	GWC 0031A
	Grab-Line Clamp	GWC 0032A
	Grab-Line 'D' shackle	GWC 0033A
	Cable gland	GWC 0039

GW Range

GWN1

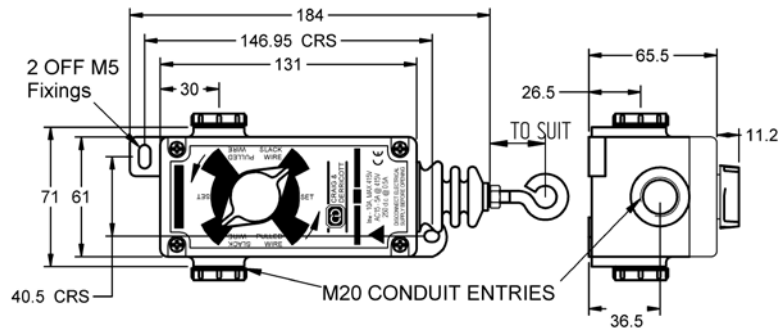

GWN2

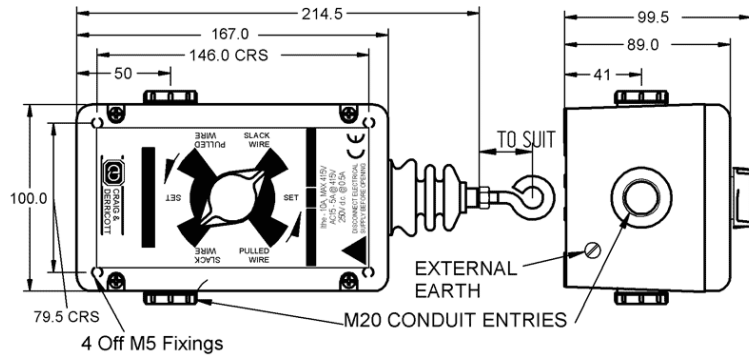

GWN2/SS

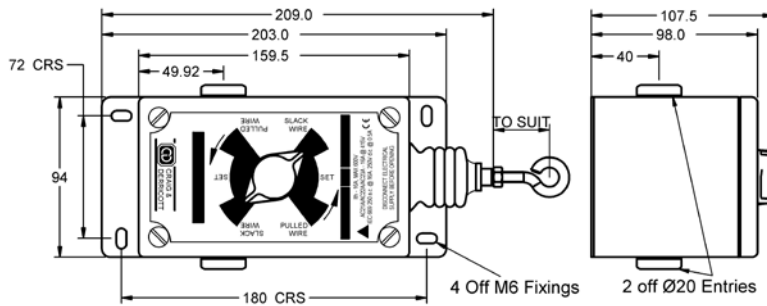

GW/AB Anchor Box

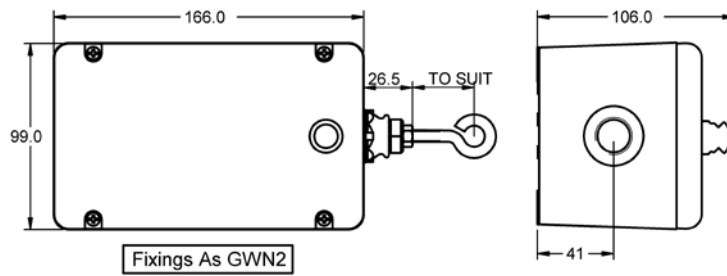

GWDE

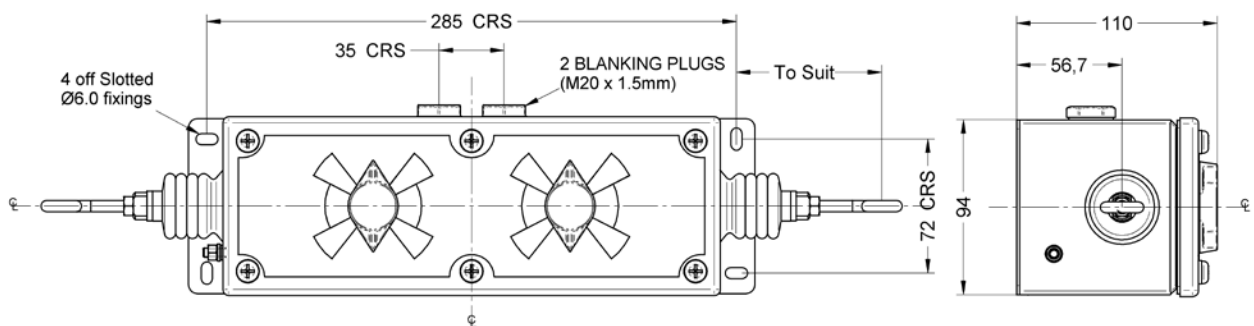

LW Range

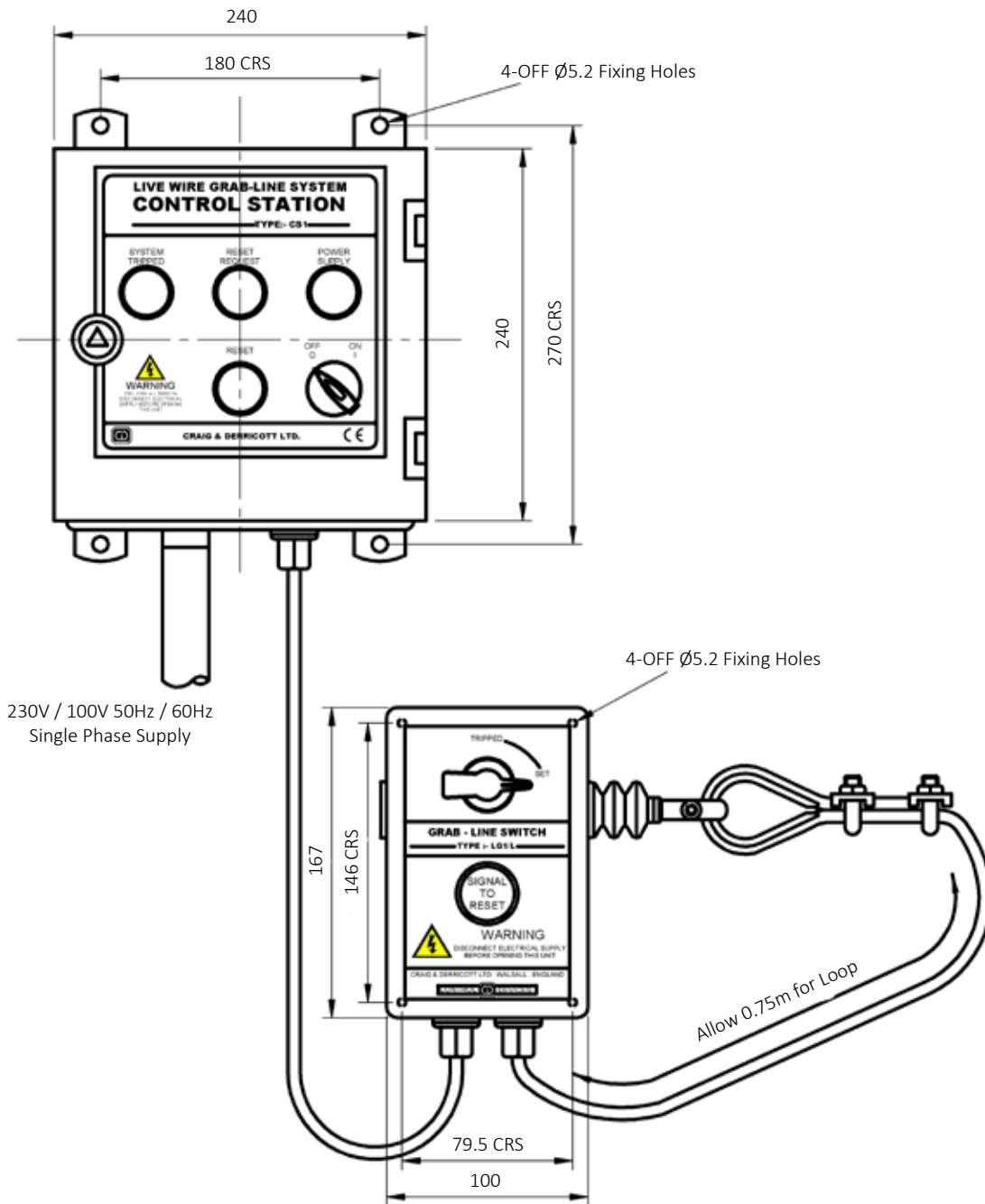

Application		
Input Voltage		110V (15W max.), 240V (15W max)
System Voltage		24V a.c. - 1/2 wave rectified
Control Circuit Relay	Contact Operation	Positively operated
	Rated Load	3A at 240V a.c. 3A (Resistive) at 24V d.c.
	Max. Switching Current	6A
	Max. Switching Voltage	250V a.c. & 24V d.c
	Minimum Permissible Load	5V d.c. - 10mA
	Mechanical / Electrical Life	10 x 10 ⁶ /10 x 10 ³
	Contact Resistance	100 mΩ
Power Protection Fuse		2A
Safety Circuit Fuse		200mA
Max. Grab-Line Circuit Resistance		50 Ohms
Pull Force To Operate		Approx 5kg.

Full documentation and installation instructions are supplied with each control station